

# Magnum System

Sedia Dama

**SCAVOLINI**

# Magnum System

Sedia Dama

**SCAVOLINI™**

# BOSTON

Magnum System



Tavolo rettangolare con piano allungabile a doppia apertura laterale. Disponibile in laminato e impiallacciato. Basamento e gambe in metallo verniciato Nero, Bianco, Titanio, Bronzo o Grigio Grafite.

Rectangular table with double side opening extensible top. Available in laminate and veneered. Frame and legs in Black, White, Titanium, Bronze or Graphite Grey painted metal.

Tavolo 160x90 cm, piano rettangolare allungabile a 210x120 cm. Basamento e gambe in metallo verniciato Titanio. Piano sagomato laminato Statuario. Magnum System doppia apertura laterale. Sedia Havana, struttura in metallo verniciato Titanio, seduta e schienale rivestiti in tessuto Damascato 06.

160x90 cm table, rectangular top extends up to 210x120 cm. Frame and legs in Titanium painted metal. Statuario laminate shaped top. Magnum System double side opening. Havana chair, Titanium painted metal frame, seat and back covered in Damascato 06 fabric.

BOSTON





Tavolo 160x90 cm,  
piano rettangolare  
allungabile a 210x120 cm.  
Basamento e gambe  
in metallo verniciato Titanio.  
Piano sagomato laminato Statuario.  
Magnum System doppia apertura  
laterale.  
Sedia Havana, struttura, seduta  
e schienale rivestiti in tessuto  
Teknofibra Nabuk 38.

160x90 cm table,  
rectangular top  
extends up to 210x120 cm.  
Frame and legs in Titanium  
painted metal.  
Statuario laminate shaped top.  
Magnum System double  
side opening.  
Havana chair, frame, seat and back  
covered in Teknofibra Nabuk 38  
fabric.



BOSTON



Tavolo 160x90 cm, piano rettangolare allungabile a 210x120 cm.  
 Basamento e gambe in metallo verniciato Titanio.  
 Piano sagomato laminato Statuario.  
 Magnum System doppia apertura laterale.  
 Sedia Havana, struttura in metallo verniciato Titanio, seduta e schienale rivestiti in tessuto Damascato 06.

160x90 cm table, rectangular top extends up to 210x120 cm.  
 Frame and legs in Titanium painted metal.  
 Statuario laminate shaped top.  
 Magnum System double side opening.  
 Havana chair, Titanium painted metal frame, seat and back covered in Damascato 06 fabric.

# PARIS

Magnum System



Tavolo rettangolare con piano allungabile a doppia apertura laterale. Disponibile in laminato e impiallacciato. Basamento e gambe in metallo verniciato Nero, Bianco, Titanio, Bronzo o Grigio Grafite.

Rectangular table with double side opening extensible top. Available in laminate and veneered. Frame and legs in Black, White, Titanium, Bronze or Graphite Grey painted metal.





Tavolo 200x100 cm, piano rettangolare allungabile a 260x130 cm. Basamento e gambe in metallo verniciato Nero. Piano sagomato impiallacciato Rovere Berry. Magnum System doppia apertura laterale. Poltroncina Egg, struttura Rovere Berry, seduta e schienale rivestiti in tessuto Viki 05.

200x100 cm table, rectangular top extends up to 260x130 cm. Frame and legs in Black painted metal. Berry Oak veneered shaped top. Magnum System double side opening. Egg armchair, Berry Oak frame, seat and back covered in Viki 05 fabric.



Tavolo 160x90 cm, piano rettangolare allungabile a 210x120 cm.  
 Basamento e gambe in metallo verniciato Nero.  
 Piano sagomato impiallacciato Rovere Pecan.  
 Magnum System doppia apertura laterale.  
 Sedia Dama, struttura, seduta e schienale rivestiti in tessuto Teknofibra Nabuk 22.

160x90 cm table, rectangular top extends up to 210x120 cm.  
 Frame and legs in Black painted metal.  
 Pecan Oak veneered shaped top.  
 Magnum System double side opening.  
 Dama chair, frame, seat and back covered in Teknofibra Nabuk 22 fabric.



# OSAKA

Magnum System



Tavolo rettangolare con piano allungabile a doppia apertura laterale. Disponibile in laminato e impiallacciato. Basamento e gambe in metallo verniciato Nero, Bianco, Titanio, Bronzo o Grigio Grafite.

Rectangular table with double side opening extensible top. Available in laminate and veneered. Frame and legs in Black, White, Titanium, Bronze or Graphite Grey painted metal.





Tavolo 140x90 cm,  
piano rettangolare  
allungabile a 180x120 cm.  
Basamento e gambe  
in metallo verniciato Nero.  
Piano sagomato laminato  
Pietra Abyss.  
Magnum System doppia  
apertura laterale.  
Sedia Havana, struttura  
in metallo verniciate Nero,  
seduta e schienale rivestiti  
in tessuto Viki 15.

140x90 cm table,  
rectangular top  
extends up to 180x120 cm.  
Frame and legs  
in Black painted metal.  
Abyss Stone laminate  
shaped top.  
Magnum System double  
side opening.  
Havana chair, Black painted  
metal frame, seat and back  
covered in Viki 15 fabric.



OSAKA



Tavolo 140x90 cm, piano rettangolare allungabile a 180x120 cm. Basamento e gambe in metallo verniciato Nero. Piano sagomato laminato Pietra Abyss. Magnum System doppia apertura laterale. Sedia Dama, struttura, seduta e schienale rivestiti in tessuto Teknofibra Nabuk 38.

140x90 cm table, rectangular top extends up to 180x120 cm. Frame and legs in Black painted metal. Abyss Stone laminate shaped top. Magnum System double side opening. Dama chair, frame, seat and back covered in Teknofibra Nabuk 38 fabric.

Tavolo 200x100 cm,  
 piano rettangolare  
 allungabile a 260x130 cm.  
 Basamento e gambe  
 in metallo verniciato Titanio.  
 Piano sagomato laminato  
 Pietra Venus.  
 Magnum System doppia  
 apertura laterale.  
 Sedia Fifties, struttura  
 in metallo verniciate Bronzo,  
 seduta e schienale rivestiti  
 in tessuto Viki/Viki 09 TS.

200x100 cm table,  
 rectangular top  
 extends up to 260x130 cm.  
 Frame and legs  
 in Titanium painted metal.  
 Venus Stone  
 laminate shaped top.  
 Magnum System double  
 side opening.  
 Fifties chair,  
 Bronze painted metal  
 frame, seat and back covered  
 in Viki/Viki 09 TS fabric.



# LUXOR

Magnum System



Tavolo rettangolare con piano allungabile a doppia apertura laterale. Disponibile in laminato e impiallacciato. Basamento e gambe in metallo verniciato Nero, Bianco, Titanio, Bronzo o Grigio Grafite.

Rectangular table with double side opening extensible top. Available in laminate and veneered. Frame and legs in Black, White, Titanium, Bronze or Graphite Grey painted metal.



Tavolo 160x90 cm, piano rettangolare allungabile a 210x120 cm. Basamento e gambe in metallo verniciato Nero. Piano sagomato impiallacciato Rovere Pecan. Magnum System doppia apertura laterale. Sedia Pin struttura Rovere Pecan, seduta e schienale rivestiti in tessuto Norris 02.

160x90 cm table, rectangular top extends up to 210x120 cm. Frame and legs in Black painted metal. Pecan Oak veneered shaped top. Magnum System double side opening. Pin chair, Pecan Oak frame, seat and back covered in Norris 02 fabric.

LUXOR

Tavolo 160X90 cm,  
 piano rettangolare  
 allungabile a 210X120 cm.  
 Basamento e gambe  
 in metallo verniciato Nero.  
 Piano sagomato impiallacciato  
 Rovere Pecan.  
 Magnum System doppia  
 apertura laterale.  
 Sedia Dama, struttura,  
 seduta e schienale  
 rivestiti in tessuto  
 Teknofibra Nabuk 41.

160x90 cm table,  
 rectangular top  
 extends up to 210x120 cm.  
 Frame and legs  
 in Black painted metal.  
 Pecan Oak  
 veneered shaped top,  
 Magnum System double  
 side opening.  
 Dama chair, frame,  
 seat and back covered in  
 Teknofibra Nabuk 41 fabric.





Tavolo 160X90 cm, piano rettangolare  
allungabile a 210X120 cm.  
Basamento e gambe in metallo verniciato Nero.  
Piano sagomato impiallacciato Rovere Pecan.  
Magnum System doppia apertura laterale.  
Sedia Dama, struttura, seduta e schienale rivestiti  
in tessuto Teknofibra Nabuk 41.

160x90 cm table, rectangular top  
extends up to 210x120 cm.  
Frame and legs in Black painted metal.  
Pecan Oak veneered shaped top.  
Magnum System double side opening.  
Dama chair, frame, seat and back covered  
in Teknofibra Nabuk 41 fabric.



Tavolo 180x100 cm,  
piano rettangolare  
allungabile a 240x130 cm.  
Basamento e gambe  
in metallo verniciato Nero.  
Piano squadrato laminato  
Bologna.  
Magnum System doppia  
apertura laterale.  
Sedia Dama, struttura,  
seduta e schienale rivestiti  
in tessuto Teknofibra  
Nabuk 41.

180x100 cm table,  
rectangular top  
extends up to 240x130 cm.  
Frame and legs in Black  
painted metal.  
Bologna laminate squared top.  
Magnum System double  
side opening.  
Dama chair, frame, seat  
and back covered  
in Teknofibra Nabuk 41 fabric.





Tavolo 200x100 cm, piano rettangolare allungabile a 260x130 cm. Basamento e gambe in metallo verniciato Nero. Piano squadrato laminato Bologna. Magnum System doppia apertura laterale. Sedia Dama, struttura, seduta e schienale rivestiti in tessuto Teknofibra Nabuk 41.

200x100 cm table, rectangular top extends up to 260x130 cm. Frame and legs in Black painted metal. Bologna laminate squared top. Magnum System double side opening. Dama chair, frame, seat and back covered in Teknofibra Nabuk 41 fabric.

# MAGNUM SYSTEM

Schema di apertura allunghe

Extension opening mechanism.

Un sistema di allunghe innovativo. Il meccanismo di estensione, fluido e invisibile, permette di ampliare la superficie del tavolo garantendo spazio extra senza compromettere l'eleganza del design.

An innovative extension system. The smooth and invisible extension mechanism allows the table surface to be expanded, providing extra space without compromising the elegance of the design.

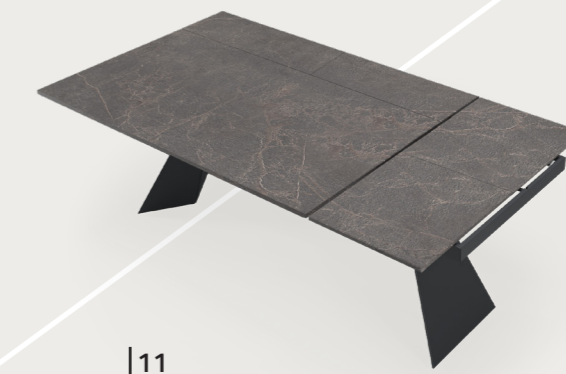
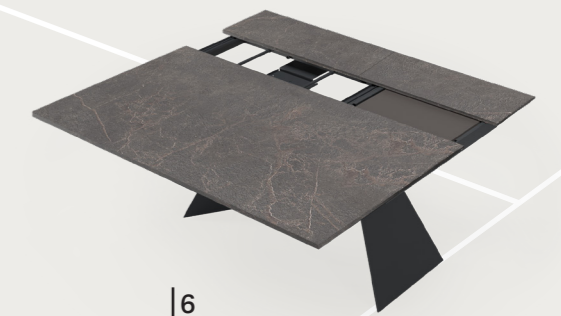
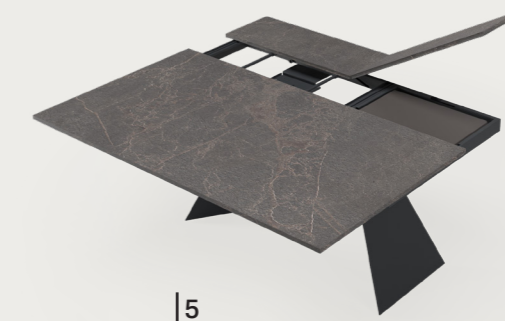
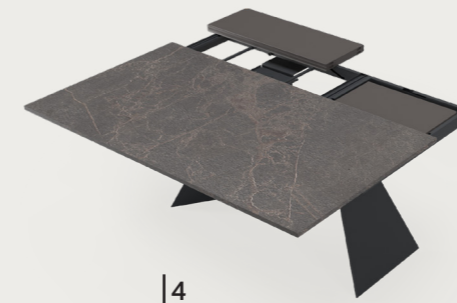
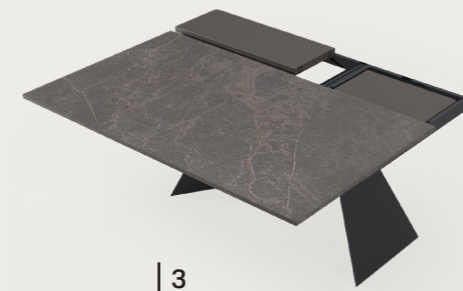
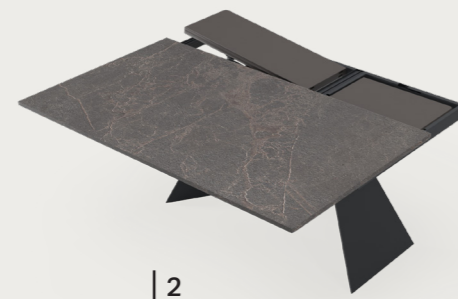

LAMINATI . LAMINATES

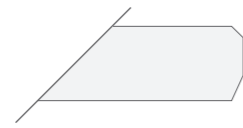

PROFILO BORDO LACCATO  
LACQUERED EDGE PROFILE

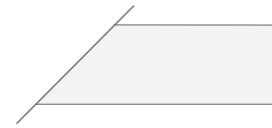

PROFILO BORDO ABS  
ABS EDGE PROFILE

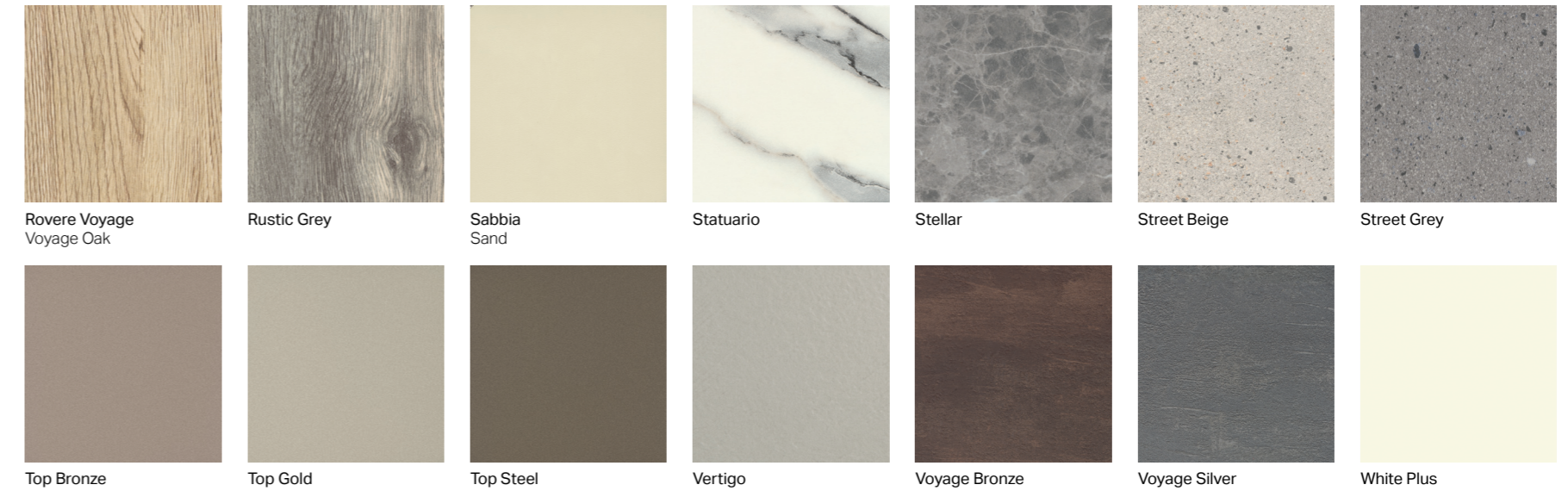

IMPIALLACCIATI . VENEERED

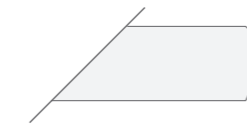

PROFILO BORDO LACCATO  
LACQUERED EDGE PROFILE

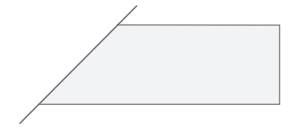

PROFILO BORDO LEGNO  
VENEERED EDGE PROFILE

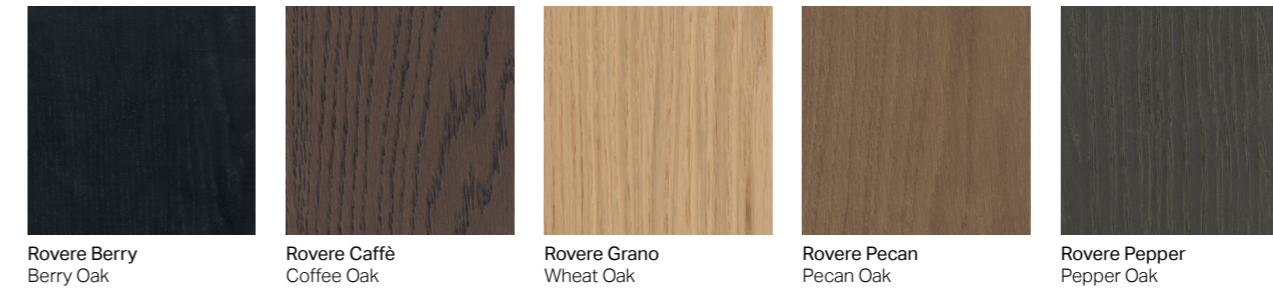

BASAMENTO E GAMBE . FRAME AND LEGS

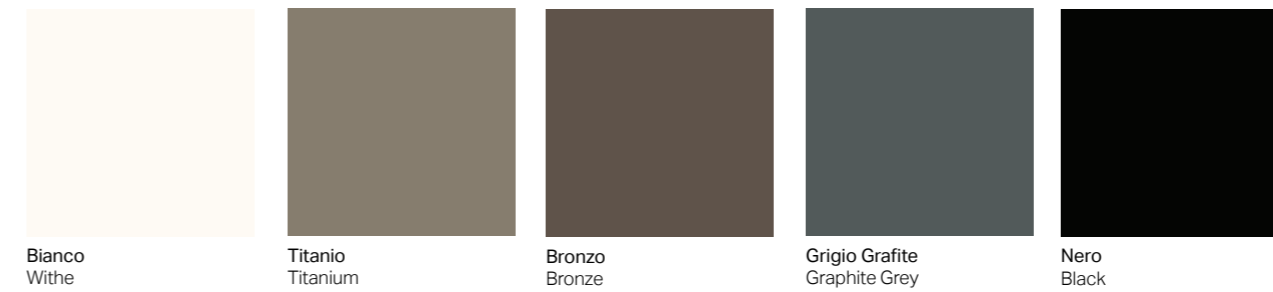

# DAMA

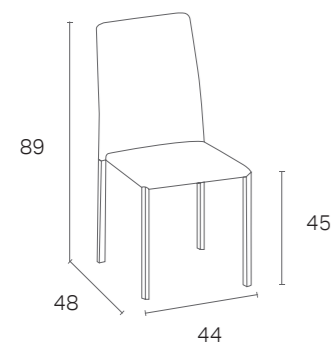

**SCHEDA PRODOTTO**  
Struttura in metallo verniciato o rivestito in tessuto; seduta e schienale rivestiti in tessuto.

**PRODUCT SPECIFICATIONS**  
Frame in painted metal or covered in fabric; seat and back covered in fabric.



Struttura, seduta e schienale rivestiti in tessuto Teknofibra Nabuk 32.

Frame, seat and back covered in Teknofibra Nabuk 32 fabric.



Per informazioni su finiture disponibili consultare il seguente QR Code  
Scan the QR Code for further information about the available finishes.

# MAGNUM SYSTEM

## SCHEDA PRODOTTO

Basamento e gambe in metallo verniciato.  
Piano allungabile con doppia apertura laterale, pannello di particelle di legno rivestito in laminato o impiallacciato, con profilo sagomato (bordo laccato) o squadrato (bordo ABS per i piani laminato e bordo legno per i piani impiallacciati).  
Le allunghe sono dello stesso materiale e colore del piano.

## PRODUCT SPECIFICATIONS

Frame and legs in painted metal.  
Double side opening extensible top, wood particle board panel covered in laminate or veneered, with shaped profile (lacquered edge) or squared profile (ABS edge for laminate tops and wooden edge for veneered tops).  
The extensions are in the same material and colour as the top.

PROFILO BORDO DEL PIANO  
TOP EDGE PROFILE

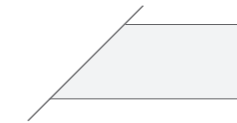

LAMINATO SP.2 CM  
IMPIALLACCIATO SP. 2 CM  
2 CM TH LAMINATE  
2 CM TH VENEERED

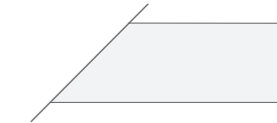

LAMINATO SP.2 CM  
IMPIALLACCIATO SP. 2 CM  
2 CM TH LAMINATE  
2 CM TH VENEERED

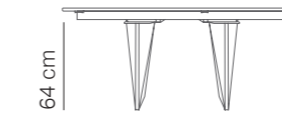

BASE BOSTON  
BOSTON FRAME

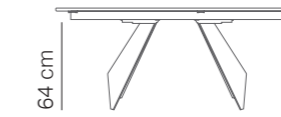

BASE LUXOR  
LUXOR FRAME

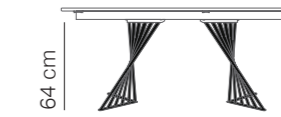

BASE PARIS  
PARIS FRAME

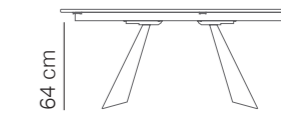

BASE OSAKA  
OSAKA FRAME

## DATI TECNICI

### TECHNICAL DATA

FINITURE DISPONIBILI:  
Laminato; Impiallacciato  
AVAILABLE FINISHES:  
Laminate; Veneered

<p>140 cm 90 cm</p>	<p>180 cm 120 cm</p>	<p>1 allunga a libro da 140x30 cm 1 allunga a libro da 120x40 cm 1 140x30 cm folding extension 1 120x40 cm folding extension</p>
<p>160 cm 90 cm</p>	<p>210 cm 120 cm</p>	<p>1 allunga a libro da 160x30 cm 1 allunga a libro da 120x50 cm 1 160x30 cm folding extension 1 120x50 cm folding extension</p>
<p>180 cm 100 cm</p>	<p>240 cm 130 cm</p>	<p>1 allunga a libro da 180x30 cm 1 allunga a libro da 130x60 cm 1 180x30 cm folding extension 1 130x60 cm folding extension</p>
<p>200 cm 100 cm</p>	<p>260 cm 130 cm</p>	<p>1 allunga a libro da 200x30 cm 1 allunga a libro da 130x60 cm 1 200x30 cm folding extension 1 130x60 cm folding extension</p>

## DATI TECNICI

### TECHNICAL DATA

SEDIA DAMA  
DAMA CHAIR

COD. 73050433

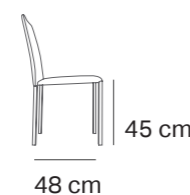
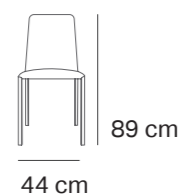

## LISTINO PREZZI

### PRICE LIST

	Laminato Sagomato H.20 cm allunghe Sagomate Shaped Laminate H.20 cm with Shaped extensions	Impiallacciato Sagomato H.20 cm allunghe Sagomate Shaped Veneered H.20 cm with Shaped extensions	Laminato Bordo Dritto H.20 cm Allunghe Bordo Dritto Straight Edge Laminate H.20 cm Straight Edge Extensions	Impiallacciato Bordo Dritto H.20 cm Straight Edge Veneered H.20 cm Straight Edge Extensions
COD. 73050417 - BOSTON	€ 000,00	€ 000,00	€ 000,00	€ 000,00
COD. 73050421 - LUXOR	€ 000,00	€ 000,00	€ 000,00	€ 000,00
COD. 73050425 - OSAKA	€ 000,00	€ 000,00	€ 000,00	€ 000,00
COD. 73050429 - PARIS	€ 000,00	€ 000,00	€ 000,00	€ 000,00
COD. 73050417 - BOSTON	€ 000,00	€ 000,00	€ 000,00	€ 000,00
COD. 73050421 - LUXOR	€ 000,00	€ 000,00	€ 000,00	€ 000,00
COD. 73050425 - OSAKA	€ 000,00	€ 000,00	€ 000,00	€ 000,00
COD. 73050429 - PARIS	€ 000,00	€ 000,00	€ 000,00	€ 000,00
COD. 73050417 - BOSTON	€ 000,00	€ 000,00	€ 000,00	€ 000,00
COD. 73050421 - LUXOR	€ 000,00	€ 000,00	€ 000,00	€ 000,00
COD. 73050425 - OSAKA	€ 000,00	€ 000,00	€ 000,00	€ 000,00
COD. 73050429 - PARIS	€ 000,00	€ 000,00	€ 000,00	€ 000,00
COD. 73050417 - BOSTON	€ 000,00	€ 000,00	€ 000,00	€ 000,00
COD. 73050421 - LUXOR	€ 000,00	€ 000,00	€ 000,00	€ 000,00
COD. 73050425 - OSAKA	€ 000,00	€ 000,00	€ 000,00	€ 000,00
COD. 73050429 - PARIS	€ 000,00	€ 000,00	€ 000,00	€ 000,00

	Ares	Atena	Iago	Tekn. Nabuk	Norris	Riccio	Viki	Viki-Viki Ts	Viki Ts	Damascato	Teknoskin	Uruguay
Struttura metallo verniciato Painted metal frame	€ 000,00	€ 000,00	€ 000,00	€ 000,00	€ 000,00	€ 000,00	€ 000,00	€ 000,00	€ 000,00	€ 000,00	€ 000,00	€ 000,00
Struttura metallo rivestito Covered metal frame	€ 000,00	€ 000,00	€ 000,00	€ 000,00	€ 000,00	€ 000,00	€ 000,00	€ 000,00	€ 000,00	€ 000,00	€ 000,00	€ 000,00

Vieni a scoprire con i tuoi occhi il mondo Scavolini, presso i nostri Rivenditori potrai trovare un'ampia gamma di prodotti esposti, i cataloghi e tantissimo altro materiale informativo.

Come and discover the world of Scavolini with your own eyes. At our authorised Dealers, you will find a wide range of products on display, along with our catalogues and a wealth of informative material.

Il presente catalogo è fornito dalla Scavolini SpA alla propria clientela che potrà liberamente consegnarlo al pubblico; non potrà invece assolutamente consegnarlo, nemmeno in forma riprodotta, a soggetti che svolgano attività commerciali nel settore (ad esempio agenti di commercio, commercianti, ecc...) in qualsiasi paese del mondo. Salvo eventuali deroghe, che dovranno risultare da atto scritto della Scavolini SpA, ogni violazione a quanto sopra sarà perseguita legalmente. Rb'unkhnh Ro' rtookhr sghr b's'knftd sn hsr bkhdmsdkd+ vgn `qd `tsgnqhrdc sn chrsqhatsd hs sn ldladqr ne sgd otakhb vhsq mn qdrsqhbsnhmr- Gnvduq+ hs l'x mns ad fhudm+ dudm hm bnohdc enql+ sn `mnm dm hm atrhmdrr hm sgd Jssdc jhsbgdm rdbsnq `d-f- `fdmsr+ cd`kdqr+ dsb-(` `mxvgdqdm hm sgd vnqkc- Tmkdrr `tsgnqhrdc hm vqshsmf ax Rb'unkhnh Ro'+ `kk aqd`bgdr ne sgd `anud bnmchshnmr vhhk qdrtkh hm oqndrbtshnm-



Scavolini è dotata del Sistema di Gestione della Qualità in conformità alla normativa ISO 9001, ed anche del Sistema di Gestione Ambientale in conformità alla norma ISO 14001. Non solo, Scavolini è anche la prima azienda italiana nel settore cucina ad avere implementato un Sistema di Gestione Salute e Sicurezza in conformità alla norma ISO 45001. Tutti i Sistemi sono stati certificati da parte dell'Ente Internazionale SGS, che ha conferito a Scavolini il prestigioso premio Merit Award proprio a testimonianza dell'eccellenza raggiunta dall'azienda nel controllo della qualità, dell'ambiente e della sicurezza. Rb'unkhnh g'r `Pt`khsx L'm`fdldms Rxsrdl hm bnlokh`mbd vhsq sgd HRN 8//0 rs`mc`qc+ `r vdkk `r `m Dmuhqnmldms`k L'm`fdldms Rxsrdl hm bnlokh`mbd vhsq sgd HRN 03//0 rs`mc`qc- Sg`s&r mns `kk- Rb'unkhnh hr `krn sgd Jqrs Hs`kh`m jhsbgdm l'mte`bstqddq sn g`ud hlokdlmsdc `Gd`ksg `mc R`edsx L'm`fdldms Rxsrdl hm bnlokh`mbd vhsq sgd HRN 34//0 rs`mc`qc- @kk sgd Rxsrdl g`ud addm bdqshJdc ax sgd Hmsdqm`shnm`k Ancx RFR+ vgn adrsnvdv Rb'unkhnh vhsq sgd oqdrshfhnr Ldqhs @v`qc hm qdbnfmshnm ne sgd dwbdkkdmdb `bghdudc ax sgd bnlo`mx hm bnmsqkhhmf pt`khsx+ sgd dmuhqnmldms `mc`r`edsx-



Scavolini è certificata per la Catena di Custodia FSC nella gestione di una filiera trasparente e sostenibile, con approvvigionamento responsabile delle materie prime legnose, provenienti da fonti forestali correttamente gestite. Rb'unkhnh hr bdqshJdc enq sgd ERB Bg`hm ne Btrsnx hm sgd l'm`fdldms ne `sq`mro`qdms `mc`rtr`hm`akd rtookx bg`hm+ vhsq qdronmrhkd rntqshmf ne q`v vnnc l'sdqh`kr eqnl bnqqdbskx,l'm`fdc enqdrsqx rntqshmf-



Scavolini ha raggiunto l'obiettivo di autoprodurre energia verde per i propri stabilimenti. L'impianto formato da oltre 30.000 mq di pannelli fotovoltaici, prevede una produzione annua di circa 3.500.000 kWh di energia pulita che garantisce oltre l'80% del fabbisogno energetico, e l'utilizzo, quando quest'ultima non è sufficiente, di energia certificata da fonti rinnovabili. Rb'unkhnh g'r etk`jkkdc hsr `hl ne `tsnmnltrkx oqncbhmf fqddm dmdqfx enq hsr nvm ok`msr- Vhsq `sns`k`rtqe`bd`qd` ne 2/+// rp l ne ognsnunks`hb o`mdkr+ sgd rxsrdl b`m oqnuhd `m `mmt`k oqncbshnm ne `ooqnwhl`sdxx 2+4//+// jVg ne bkd`m dmdqfx sn bnudq lnqd sg`m 7/\$ ne Rb'unkhnhAr dmdqfx cdl`mc `mc+ vgdmd cdl`mc dwbdccr rtookx+ ne bdqshJdc dmdqfx eqnl qdmv`akd rntqshmf-



Scavolini ha ottenuto la Certificazione di prodotto, provenienza e qualità "Made in Italy" rilasciata da COSMOB, importante laboratorio di prova e certificazione per il legno-arredo in Italia. Questa certificazione dichiara l'origine italiana del mobile (gamma cucine, living, bagno, notte). Rb'unkhnh g'r nas`hmdc sgd AL`cd hm Hs`kxq oqncbshnm+ nqhfhm `mc`pt`khsx BdqshJb`shnm hrrtdc ax BNRLNA+ `l`inq sdrshmf `mc`bdqshJb`shnm k`anq`snqx enq vnnc,etqmhrghmfr hm Hs`kx- Sghr bdqshJb`shnm cdbk`qdr sgd Hs`kh`m nqhfhm ne etqmhrstqd`jhsbgdmr+ khuhmf qnnlr+ a`sgqnnlr `mc`adcqnnlr(-

I colori dei materiali illustrati all'interno del presente Catalogo non sempre corrispondono a quelli reali per comprensibili motivi di stampa. Colori e tonalità si possono visionare presso i Punti Vendita, direttamente su prodotti e campionari.

Sgd bnkntqr ne sgd l'sdqh`kr hkktrsq`sdv hm sgd B's`knftd gdqdhm cn mns `kv`xr l'sbg sgd `bst`k`gtd odqedsbx enq bnloqgdmrhkd oqhmsmf qd`rnmr- Bnkntqr `mc`rg`cdr b`m ad rddm `s sgd Onhmsr ne R`kd+ chqdbksx nm l'sdqh`kr `mc`r`lokd rdsr-

Il design dei prodotti Scavolini è tutelato con le modalità di legge. Inoltre, alcune parti del modello e/o alcune composizioni possono essere oggetto di brevettazione e/o registrazione.

Sgd cdrhfm ne Rb'unkhnh oqncbshnm hr oqnsdbsdc `r odqhlssdc ax k`v- Hm `cchshnm+ rnlid o`qsr ne sgd lncdk `mc`nq`bdqs`hm bnlonrshnmr l'x ad o`sdmsdc `mc`nq`qdfhrsdqdc-



Per scoprire il mondo di Scavolini, visita [www.scavolini.com](http://www.scavolini.com) dove troverai tante informazioni, curiosità e notizie sul vivere la casa.

To discover the world of Scavolini, visit [www.scavolini.com](http://www.scavolini.com), where you'll find lots of information, interesting facts and news about home lifestyles.



Questo catalogo è composto di materiale certificato FSC® e di altro materiale controllato. Sghr b's'knftd hr l'cd vhsq ERB® bdqshJdc l'sdqh`k `mc nsgdq bnmsqkhhmf l'sdqh`k-

6884.008.07.2024.1400.90120594.700

THIS CATALOGUE WAS MADE BY SCAVOLINI S.P.A. IN COLLABORATION WITH

LIFE COMUNICA GRAPHIC DESIGN

LIFE COMUNICA IMAGES

SELECOLOR FIRENZE PHOTOLITHOGRAPHS

PRINTING

